





N-Channel MOSFET

Drain Source Voltage - 20V
Continuous Drain Current - 5.2A

Features

- $V_{DS} = 20V$, $I_D = 5.2A$
- $R_{DS(ON)} < 27\ m\Omega$ @ $V_{GS} = 4.5V$
- Very Low On-Resistance $R_{DS(ON)}$
- Lead Free Product is Acquired
- Fast Switching and Low Crss

Mechanical Data

- Case: SOT23 Package
 - Case Material: UL Flammability Classification Rating 94V-0
 - Halogen Free
 - Component in Accordance to RoHS
- Note: Products with logo  or  are made by HY Electronic (Cayman) Limited.

Ordering Information

- Package :SOT23
- Reel Size :7 (inches)
- Quantity Per Reel :3,000 pcs
- Quantity One Box :45,000 pcs
- Quantity One Carton :180,000 pcs

Package Outline



SOT23 Top View

Marking Information

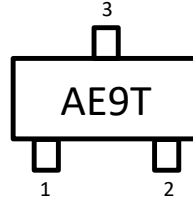

"AE9T" = Product Type Marking Code

Device Schematic & PIN Configuration

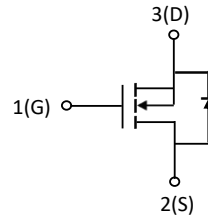

Maximum Ratings (@TA = +25°C, unless otherwise specified.)

Parameter	Symbol	Rating	Unit
Drain-Source Voltage	V_{DS}	20	V
Gate-Source Voltage	V_{GS}	± 12	V
Continuous Drain Current	I_D	$T_C = 25^\circ\text{C}$	5.2
		$T_C = 70^\circ\text{C}$	3.0
Pulsed Drain Current ^(*)	I_{DM}	16.4	A
Power Dissipation	P_D	1.0	W
Thermal Resistance Junction to Ambient	$R_{\theta JA}$	170	$^\circ\text{C/W}$
Operating and Storage Temperature Range	T_J, T_{STG}	- 55 to 150	$^\circ\text{C}$
Maximum lead temperature for soldering purposes, 1/8" from case for 5 seconds	T_L	300	$^\circ\text{C}$

Notes : Repetitive Rating : Pulse Width Limited by Maximum Junction Temperature.

Electrical Characteristics (@T_J = +25°C, unless otherwise specified.)

Parameter	Test Conditions	Symbol	Min	Typ	Max	Unit
Off Characteristics						
Drain-Source Breakdown Voltage	V _{GS} =0V, I _D =250μA	BV _{DSS}	20	-	-	V
Gate-Body Leakage Current, Forward	V _{GS} =±12V, V _{DS} =0V	I _{GSS}	-	-	±100	nA
Zero Gate Voltage Drain Current	V _{DS} =20V, V _{GS} =0V	I _{DSS}	-	-	1	μA
	V _{DS} =16V, T _C =125°C		-	-	10	μA
On Characteristics						
Gate Threshold Voltage	V _{DS} =V _{GS} , I _D =250μA	V _{GS(th)}	0.4	0.7	1.0	V
Static Drain-Source	V _{GS} =4.5V, I _D =4A		-	21	27	mΩ
On-Resistance	V _{GS} =2.5V, I _D =3A	R _{DS(on)}	-	29	44	
Dynamic Characteristics						
Input Capacitance	V _{DS} =10V, V _{GS} =0V, F=1MHz	C _{iss}	-	358	-	pF
Output Capacitance		C _{oss}	-	69	-	
Reverse Transfer Capacitance		C _{rss}	-	58	-	
Switching Characteristics						
Total Gate Charge	V _{DS} =10V, V _{GS} =4.5V, I _D =2A	Q _g	-	5.6	-	nC
Gate Source Charge		Q _{gs}	-	0.8	-	
Gate Drain Charge		Q _{gd}	-	1.0	-	
Turn-On Delay Time	V _{DS} =10V, V _{GS} =4.5V, I _D =4A, R _G =3Ω	t _{d(on)}	-	5	-	ns
Turn-On Rise Time		t _r	-	30	-	
Turn-Off Delay Time		t _{d(off)}	-	48	-	
Turn-Off Fall Time		t _f	-	36	-	
Drain-Source Diode Characteristics and Maximum Ratings						
Maximum Continuous Drain-Source Diode Forward Current		I _S	-	-	5.0	A
Maximum Pulsed Drain-Source Diode Forward Current		I _{SM}	-	-	16	A
Drain to Source Diode Forward Voltage	V _{GS} =0V, I _{SD} =4A, T _J =25°C	V _{SD}	-	-	1.2	V



Rating and Characteristic Curves

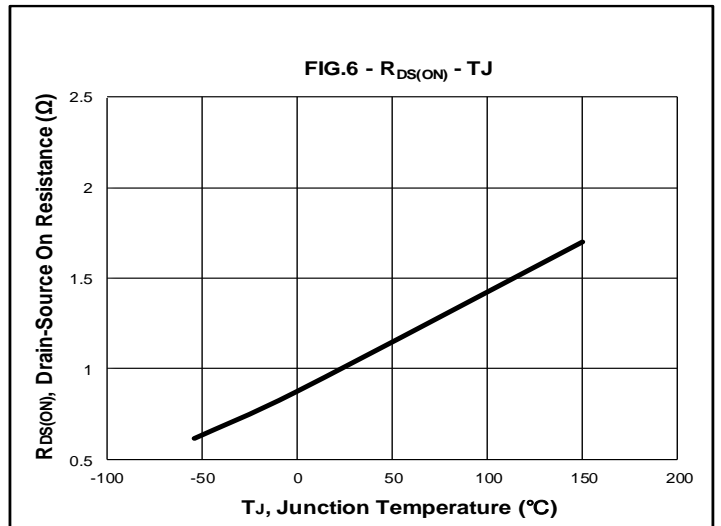
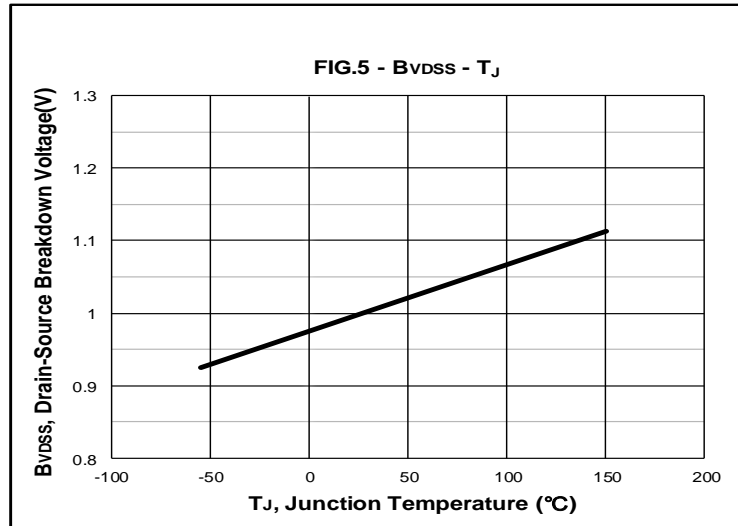
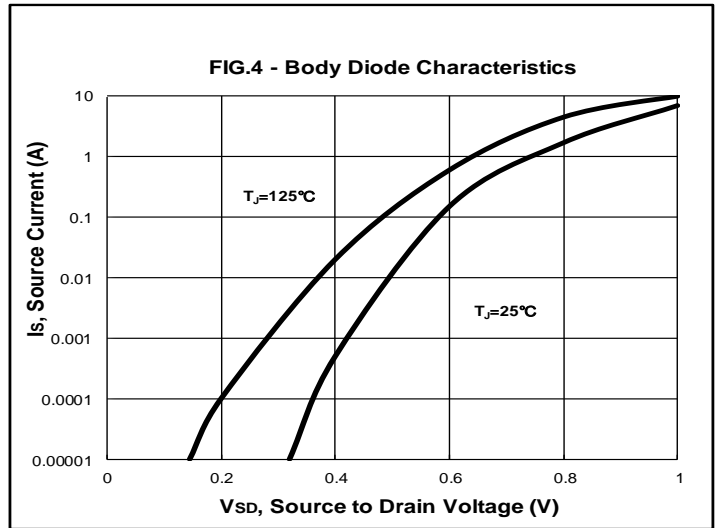
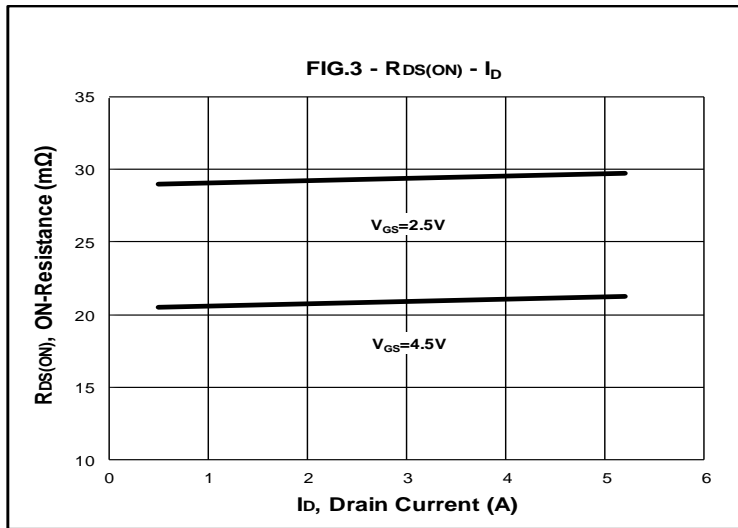
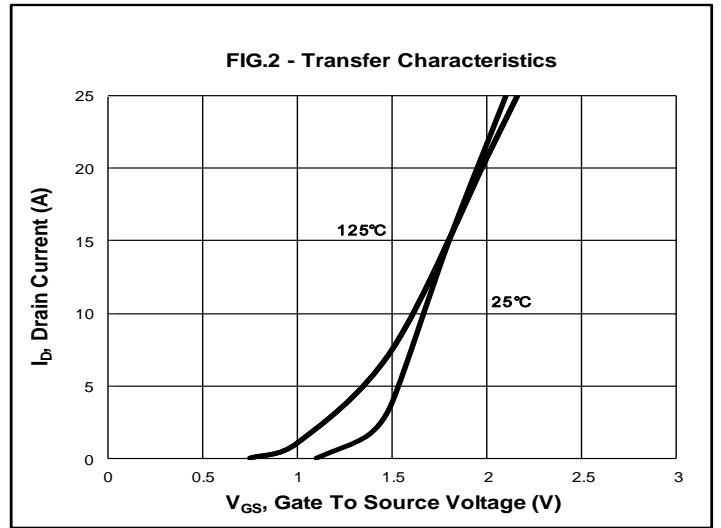
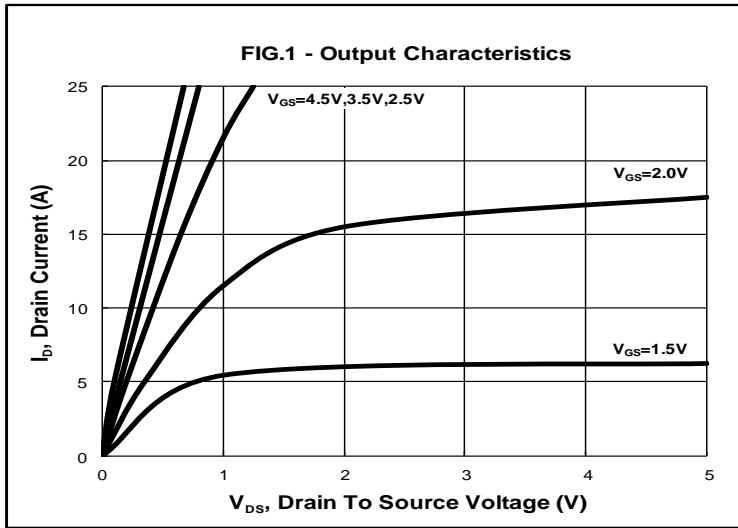



Rating and Characteristic Curves

FIG.7 - Capacitance Characteristics

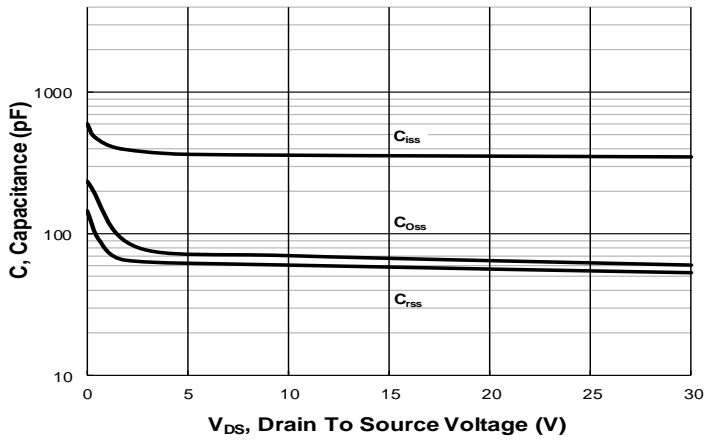

FIG.8 - Gate Charge Characteristics

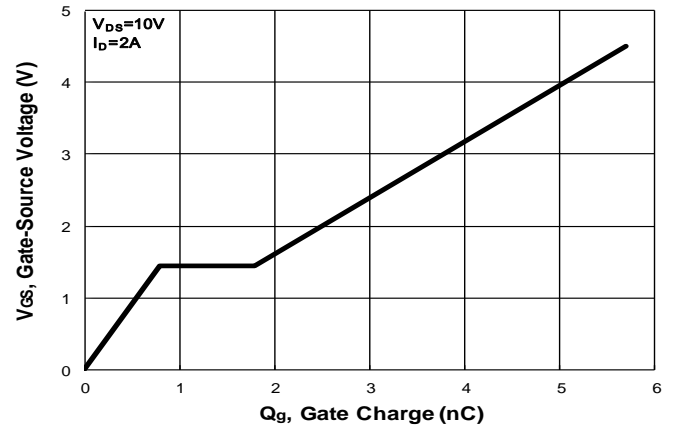

FIG.9 - $I_D - T_A$

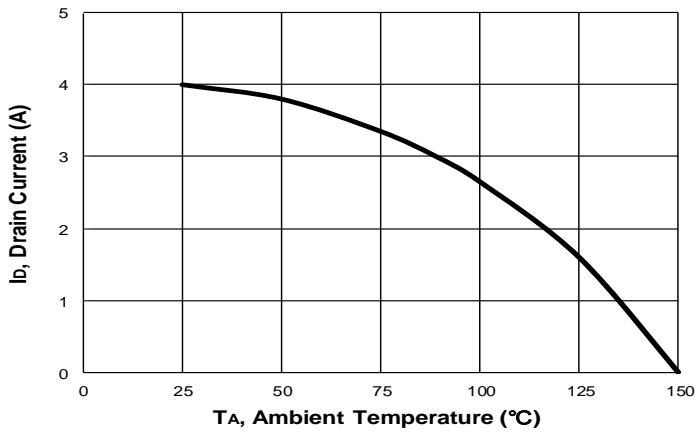
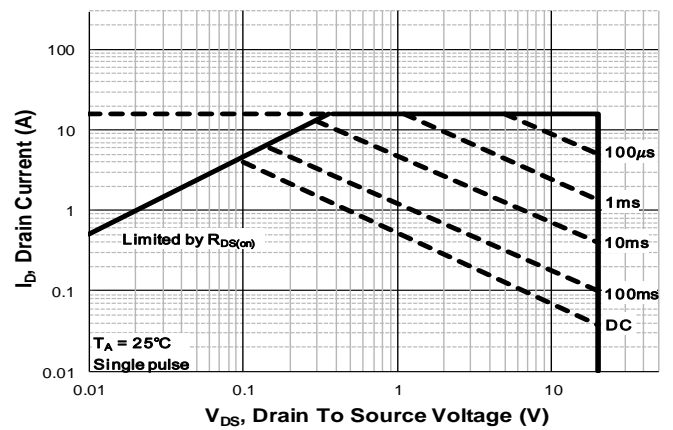
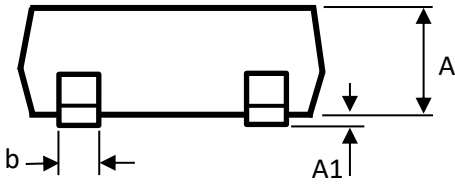
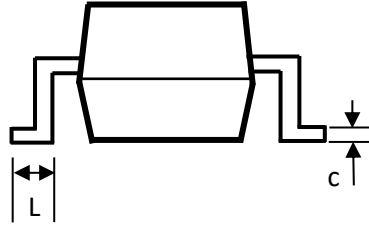
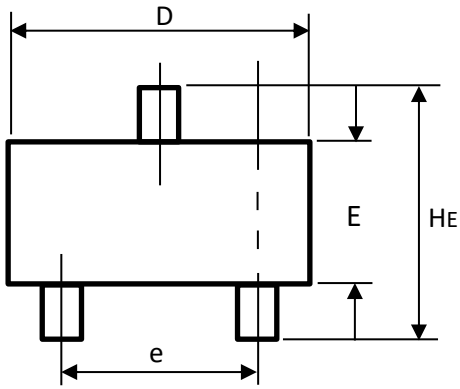

FIG.10 - Maximum Safe Operating Area





Package Outline Dimensions



SOT23 Package		
Dim	Min	Max
A	0.87	1.07
A1	0.00	0.10
b	0.30	0.50
c	0.09	0.15
D	2.80	3.00
E	1.20	1.60
e	1.80	2.00
L	0.20	0.45
HE	2.25	2.55
All Dimensions in mm		



Disclaimer

All specifications and data are subject to be changed without notice to improve reliability function or design or other reasons.

HY makes no warranty, representation or guarantee regarding the suitability of the products for any particular purpose or the continuing production of any product. To the maximum extent permitted by applicable law, HY disclaims (i) any and all liability arising out of the application or use of any product, (ii) any and all liability, including without limitation special, consequential or incidental damages, and (iii) any and all implied warranties, including warranties of fitness for particular purpose, non-infringement and merchantability.

Statements regarding the suitability of products for certain types of applications are based on HY's knowledge of typical requirements that are often placed on HY products in generic applications. Such statements are not binding statements about the suitability of products for a particular application. It is the customer's responsibility to validate that a particular product with the properties described in the product specification is suitable for use in a particular application. Parameters provided in datasheets and specifications may vary in different applications and performance may vary over time. All operating parameters, including typical parameters, must be validated for each customer application by the customer's technical experts. Product specifications do not expand or otherwise modify HY's terms and conditions of purchase, including but not limited to the warranty expressed therein.

Except as expressly indicated in writing, HY products are not designed for use in medical, life-saving, or life-sustaining applications or for any other applications in which the failure of the HY product could result in personal injury or death. Customers using or selling HY products not expressly indicated for use in such applications do so at their own risk. Please contact authorized HY personnel to obtain written terms and conditions regarding products designed for such applications.

No license, express or implied, by estoppel or otherwise, to any intellectual property rights is granted by this document or by any conduct of HY. Product names and markings noted herein may be trademarks of their respective owners.